

# KRAUSZ<sup>®</sup>

a MUELLER brand

# HYMAX<sup>®</sup> 2 (DN40-DN300)

## INSTALLATION INSTRUCTIONS

**HYMAX<sup>®</sup> 2** COUPLING AND LONG BODY COUPLING

**HYMAX<sup>®</sup> 2** FLANGE ADAPTOR AND FLANGE ADAPTOR LONG BODY AND WITH NPT OUTLET

**HYMAX<sup>®</sup> 2** REDUCER

**HYMAX<sup>®</sup> 2** THREADED OUTLET AND FLANGED OUTLET



DETECT



MONITOR



CONTROL



REPAIR

**MUELLER**

## WARNING

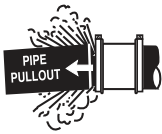

This product does not restrain axial pipe movement. Proper anchorage of the pipe is required if this product is used as a coupling. Failure to anchor the pipe ends could result in the escape of line content, and may cause property damage, serious injury or death.



**Caution:** This product is not intended for use on natural gas piping, or any other type of gas piping. To do so could result in escaping gas that could ignite and cause property damage, serious injury or death.

## IMPORTANT

- **THE HYMAX<sup>2</sup> FLIP GASKET COUPLING** is a wide-range coupling, featuring a patented flip gasket. Gasket can be easily opened by hand to accommodate larger OD pipes
- **THE HYMAX<sup>2</sup> SERIES PRODUCTS ARE STAB-ON TYPE COUPLINGS.** Do not disassemble the product. Do not lubricate nor loosen the bolts
- **DO NOT LUBRICATE BOLTS AND NUTS.** Bolts are pre-lubricated with a MAG (Molecular anti-galling) coating. Greasing bolts or nuts voids manufacturer's warranty.
- **USE A TORQUE WRENCH TO TIGHTEN THE BOLTS.** A torque wrench will assure a proper torque has been applied to the coupling. Do not use other tools to tighten the coupling's bolts!
- **LUBRICATION OF HYMAX** Except steel, PVC, and PE pipes, all rough-surfaced pipes must be lubricated with a water-based gasket lubricant in order to achieve a proper seal.
- **TIGHTEN BOLTS TO THE TORQUE** value provided on the label in one continuous step. Krausz Products do not require a gradual increase of torque over a specified period, nor do they require re-torque. The minimal torque requirements must be achieved prior to any recharging of the line.
- **PIPE STIFFENERS OR INSERTS** are recommended when used on HDPE pipes.

# PREPARE PRODUCT AND PIPE FOR INSTALLATION:

### 1

## CLEAN AND DESCALE THE PIPE

### Make sure that:

- The pipe is clear from debris.
- The pipe is not out of round and is free of scratches, dents, flats and defects
- The end rings are centered on the coupling - if they are not, please contact your local distributor for return and replacement

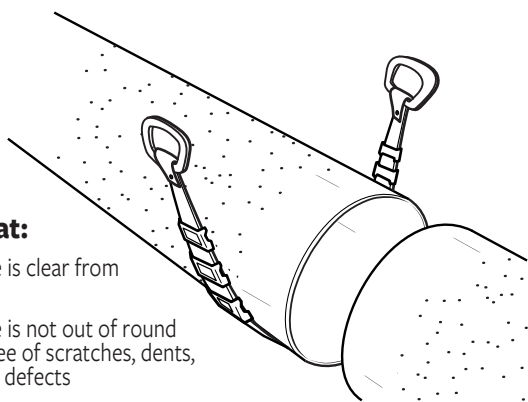

### 2

## MEASURE THE PIPES' OD TWICE

### RANGE

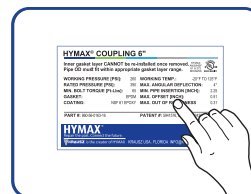

**Make sure that:**  
the coupling size range (as indicated on the product's label) will fit the pipes properly

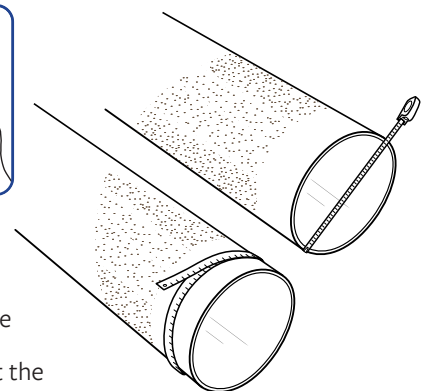

# INSTALLATION OF THE COUPLING:

**3**

## MARK EACH PIPE END FOR MINIMUM & MAXIMUM PIPE INSERTION DISTANCE

A,D Maximum stab depth for open gasket position 82.5 mm from the edge

B,C Minimum stab depth for closed gasket position 57 mm from the edge

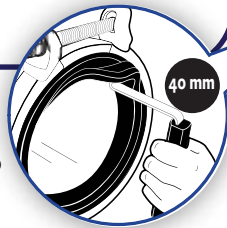
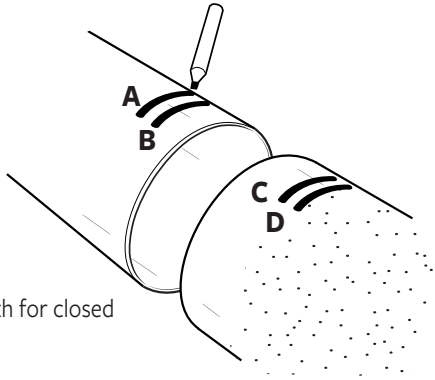

### FOR SIZE 40 mm ONLY

use a lever (provided with product) to flip the gasket out if wider pipe diameter is required.

**4**

## FLIP THE GASKET OPEN IF A LARGER OD IS REQUIRED

**A**  
↓

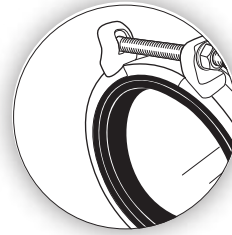

**B**  
↓

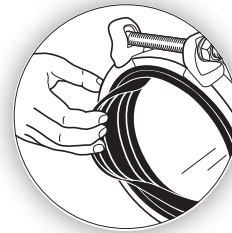

**C**

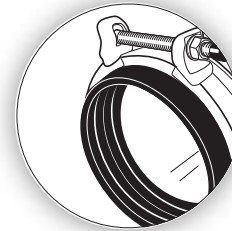

**5**

## POSITION THE COUPLING FOR INSTALLATION

- If possible, place the coupling(s) on the replacement pipe (on both ends) with top-facing bolts and lower the pipe and couplings into the ditch

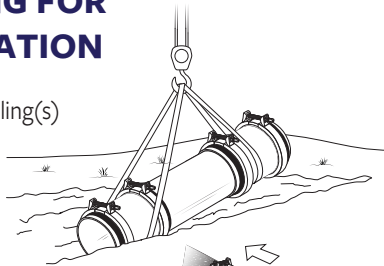

- Slide the couplings outward unto the pipes so that they cover the marks made in step 3

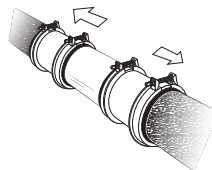

- Make sure that the pipes are not touching inside the body of the HYMAX. There must be space between the pipes in order for continuous dynamic deflection to take place

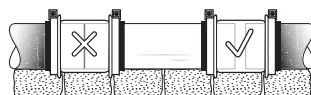

- Make sure that the pipes and the product are properly supported

- For Flange Adaptor: assemble the flange joint using flange bolts. Make sure you use a flat gasket between the flanges (not provided)

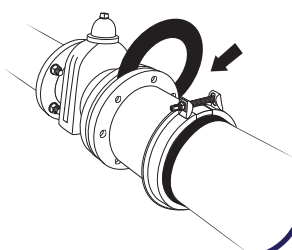

**6**

## TIGHTEN BOLTS

TORQUE

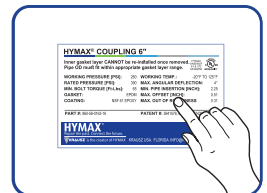
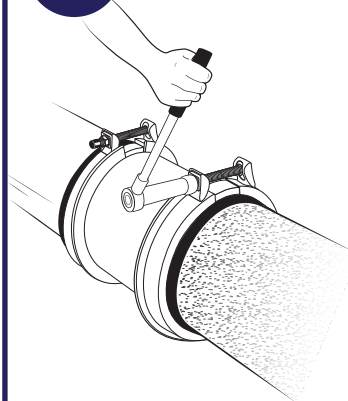

Tighten the coupling bolts to the right torque shown on the product label. When you finish, re-check the torque again

**7**

## RECHARGE

Recharge the line and check for leaks. If any leakage is evident, reduce the pressure in the line and increase bolt torque up to 50%. Verify again there are no leaks along the seal

# KRAUSZ®

---

a **MUELLER** brand

1 Harav Mantzura Str. Rosh Haayin, Israel 4850001  
Tel: +972 (0)3 5154000 | Fax: +972 (0)3 5183293  
Info@krausz.com | www.krausz.com

**To Learn More, visit [www.krausz.com](http://www.krausz.com)**

Mueller refers to one or more of Mueller Water Products, Inc., a Delaware corporation ("MWP"), and its subsidiaries. MWP and each of its subsidiaries are legally separate and independent entities when providing products and services. MWP does not provide products or services to third parties. MWP and each of its subsidiaries are liable only for their own acts and omissions and not those of each other. Mueller brands include Mueller®, Echologics®, Hydro Gate®, Hydro-Guard®, HYMAX®, i2O®, Jones®, Krausz®, Mi.Net®, Milliken®, Pratt®, Pratt Industrial®, Singer®, and U.S. Pipe Valve & Hydrant. Please see [muellerwp.com/brands](http://muellerwp.com/brands) to learn more

© 2021 Mueller Co., LLC. All Rights Reserved. The trademarks, logos and service marks displayed in this document are the property of Mueller Co., LLC., its affiliates or other third parties. Products above marked with a section symbol (§) are subject to patents or patent applications. For details, visit [www.mwppat.com](http://www.mwppat.com). These products are intended for use in potable water applications. Please contact your Mueller Sales or Customer Service Representative concerning any other application(s).

II0222 REV B 03/2022

**MUELLER**